



# XDense: A Dense Grid Sensor Network for Distributed Feature Extraction

**João Loureiro**, Raghuraman Rangaranjan, Eduardo  
Tovar, and Nuno Pereira

CISTER/INESC-TEC, ISEP  
Polytechnic Institute of Porto, Porto, Portugal

January 2015

- Dense sensing
- Applications
- Enabling dense sensing
- Related work
- Our solution
  - Principles of operation
  - Simulation model
  - Experimental results
  - Ongoing effort
- What next?

# Dense Sensing

- Current sensing approaches either indirect (Imaging) or coarse (low density of sensors)
  - > Constrained to lab/testing conditions
  
- Technologies like MEMS allow deployments of extremely dense sensors/actuators
  - Enables applications with real-time, high spatial and temporal requirements
  - Eg. Thousands of nodes in a few square meters area

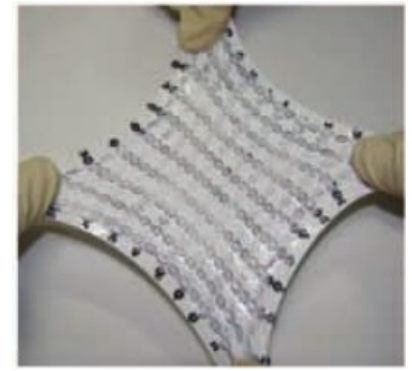
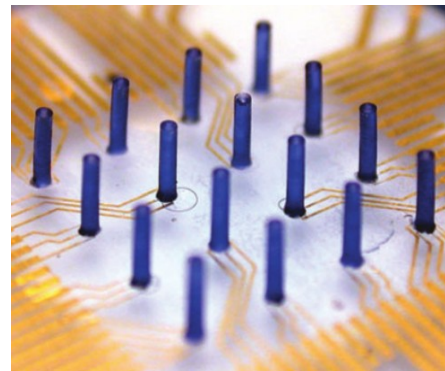
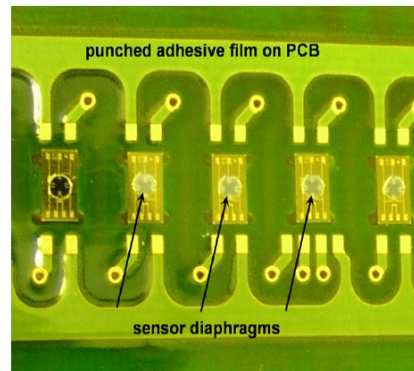
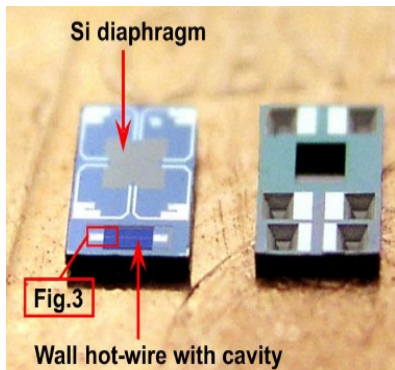

# Dense sensing applications

A sensor network architecture tailored for such scenarios is required.  
Some potential application fields:

## **Avionics**

- Flow monitoring for active flow control
- Structural and damage monitoring

## **Biomedical Devices**

- Retinal Prosthesis and implantable brain's stimulator
- Electroencephalography

## **Imaging systems**

- Micromirror arrays, for image capturing and projection
- Photonics: Optical routers

## **Robotics (e-Skins)**

- Skins of sensors to allow interaction of robots with the physical world (touch, temperature, etc.)

## Avionics

- Flow monitoring for active flow control
- Structural and damage monitoring

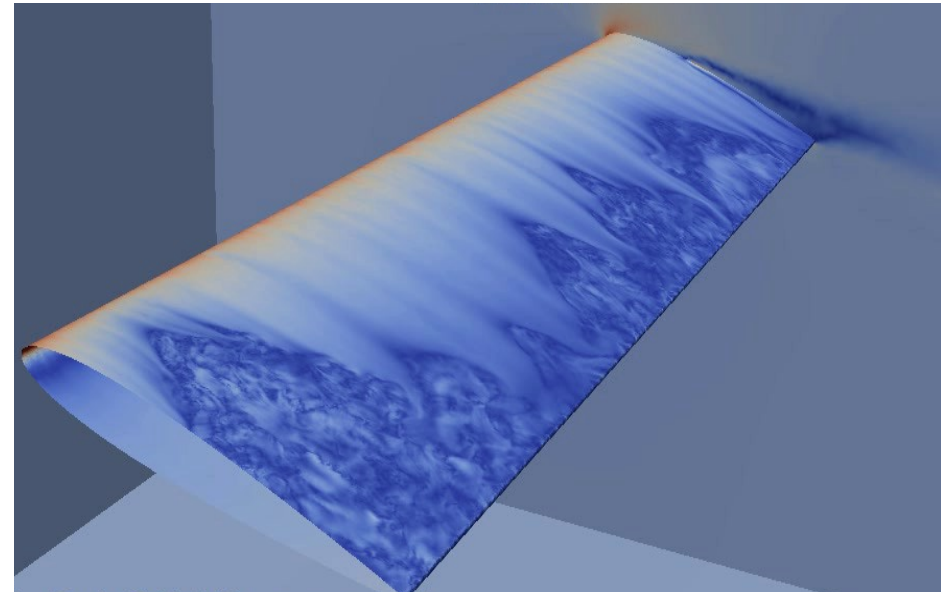
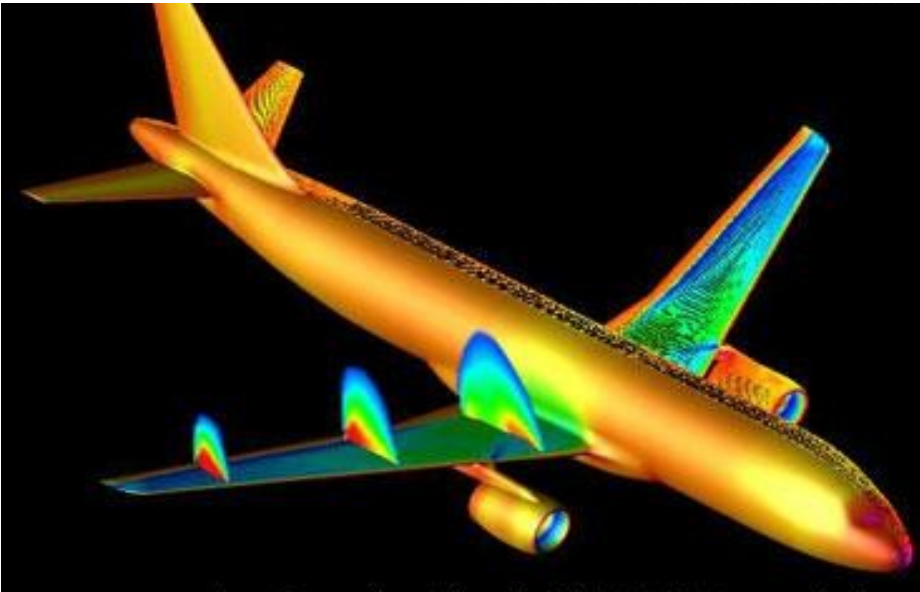

Visualization of airflow velocity profile from Computational Fluid Dynamics (CFD) simulations

21 August 2014 Last updated at 15:40 GMT



## Aircraft to be given 'human-like skin' to sense damage

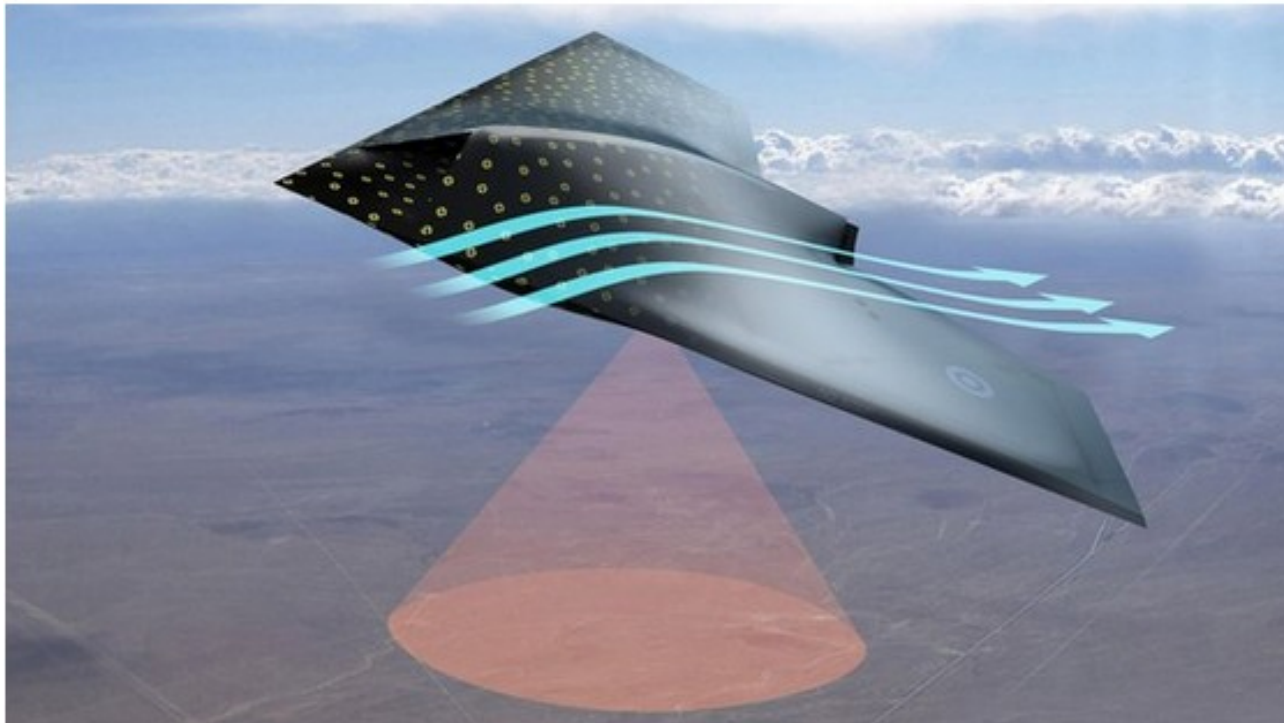

A system that allows the exterior of aircraft to "feel" damage or injury in a way similar to human skin is in development by BAE Systems.

"It could help equipment and technology to 'report back' on local environmental conditions and alert users to when repairs are needed ahead of schedule if hairline cracks are detected early, for example on flood defences and dams.

"Or it could enable water pipes to 'switch on' heating elements automatically during a particularly cold winter that would prevent pipes from freezing and bursting."

"If similar technology could be applied to cars, it could revolutionise MOT schedules and potentially reduce road accidents."

# Dense sensing applications

“NASA Tests Revolutionary Shape Changing Aircraft Flap for the First Time”

November 10, 2014



“final demonstration should prove to the aerospace industry that this technology is ready to dramatically improve aircraft efficiency,”

# Dense sensing applications

Submarines and torpedoes coated with sensors for closed loop flow control.

China recently proposed a supersonic submarine:

Wind turbines coated with flow sensors to allow real-time pitch control for optimal energy generation

## Speed machine

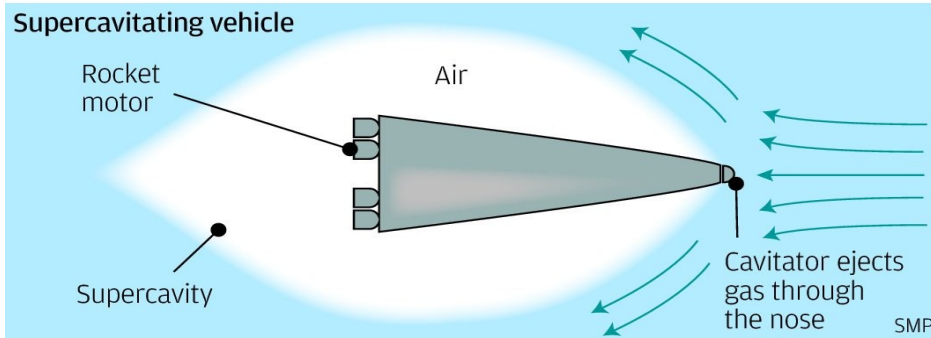
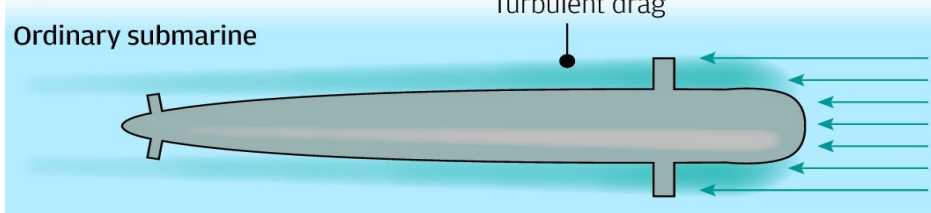

[tinyurl.com/pdq3pa4](http://tinyurl.com/pdq3pa4)



[usuaris.tinet.cat/zefir/pitch.htm](http://usuaris.tinet.cat/zefir/pitch.htm)



Other examples:

## Biomedical Devices

- Retinal Prosthesis and implantable brain's stimulator
- Electroencephalography

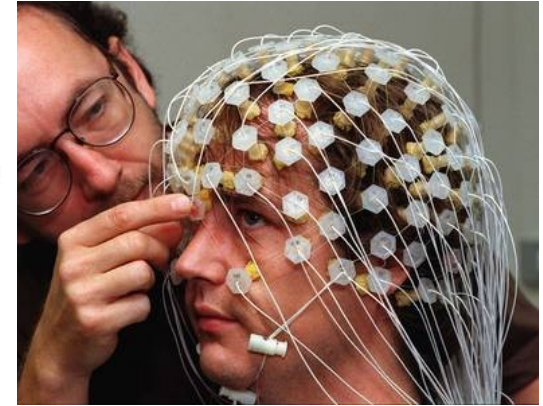
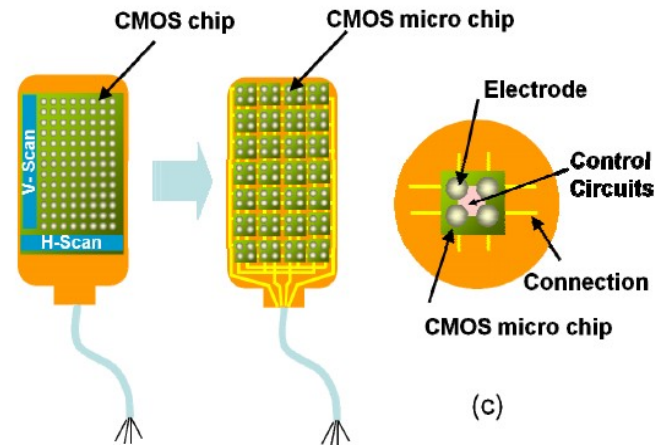

## Imaging systems

- Micromirror arrays, for image capturing and projection
- Photonic optical routers

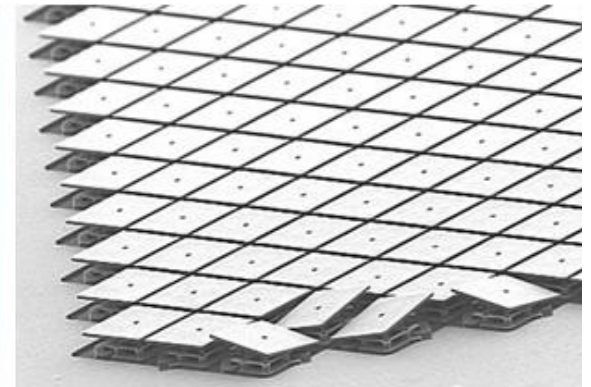
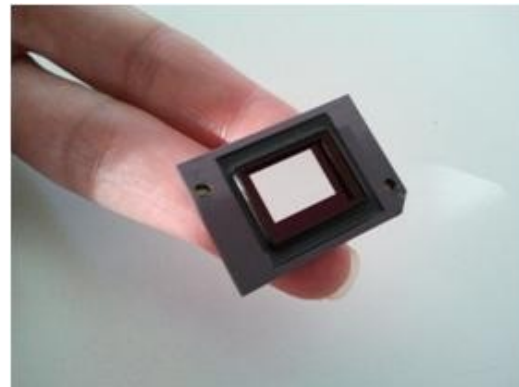

## Robotic e-Skins

- Skins of sensors to allow interaction of robots
- with the physical world (touch, temperature, etc.)

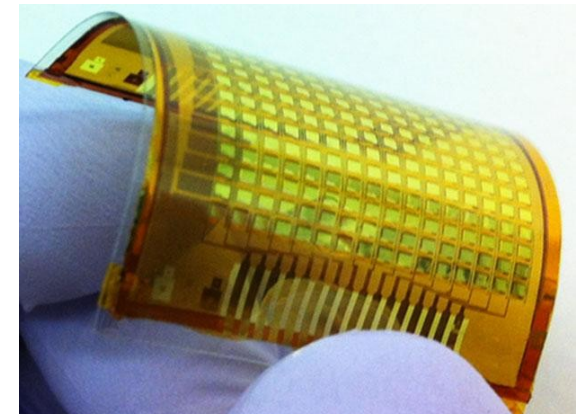

# Enabling dense sensing

Spatial and temporal scales of sensors relative to target phenomena  
(Fluctuations of up to 100 kHz and 0.1mm)

Need architectures to enable such deployment

- **Scalability:** Current topologies fail to scale
  - Shared buses suffer from noise, and concurrency issues
  - Wireless networks face power, high latency and cost issues
- **Timeliness:** Data centralization might create communication bottlenecks -> high processing times



Inter-connectivity related challenges to deal with:

## **Timeliness**

- The ultimate goal of the system is to collect a picture of a physical phenomena (that varies very rapidly), such that timely actuation is possible

## **Scalability**

- The protocols developed should preserve the response time independent of the size of the network

## **High density of sensing:**

- Deal with large quantity of sensors and data
- It should enables efficient extraction of complex features of the observed phenomena with few transmissions

# Our solution: XDense

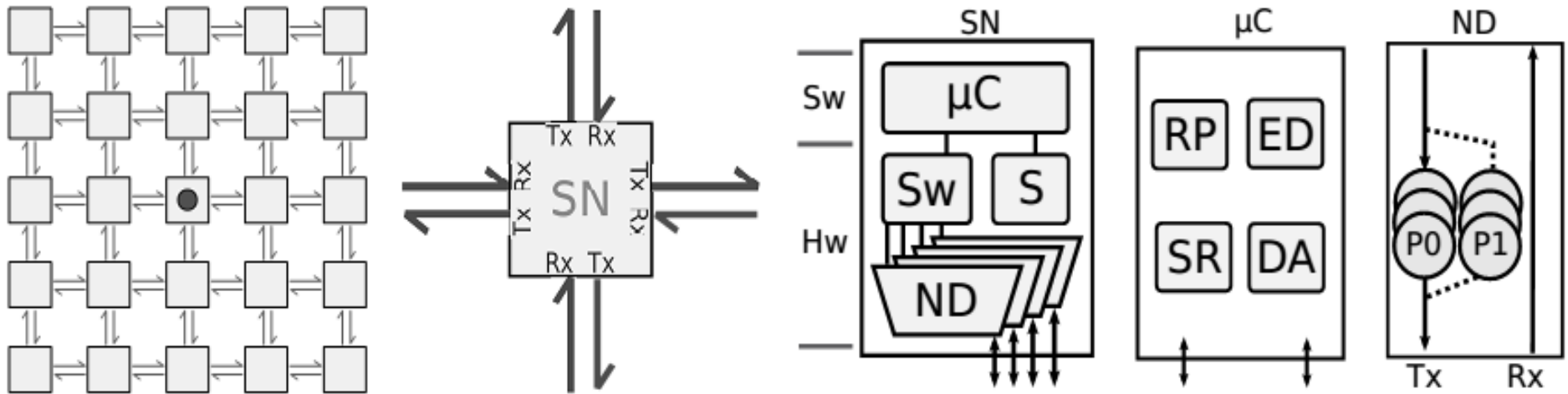

- Mesh grid sensor network, with distributed processing capabilities;
- Local data exchange and processing enables complex feature detection, and reporting of pre-processed data;
- This leads to reduced number of transmissions, and low latency.
- The growth of the network does not impact significantly on the overall latency.
- Can scale up to any size, limited only by the minimum of one sink on each node's address space

# Principle of Operation

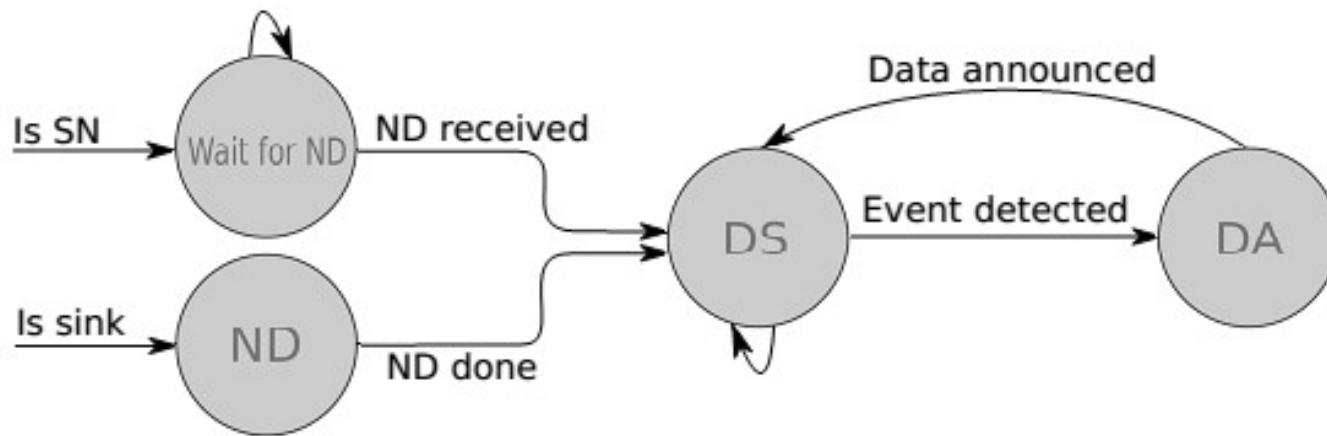

- **Network discovery (ND)**: the sink announces its location
- **Data sharing (DS)**: nodes associated with a sink, performs distributed edge detection with its n-hop neighbors data.
- **Data announcement (DA)**: if an edge with specific characteristics is detected, its value is announced towards the sink.

- **Packet content:**



- Principles of operation:

## State 1

## Network discovery

Each sink broadcasts its location.

Each node fills up a list with sinks on its "event horizon".

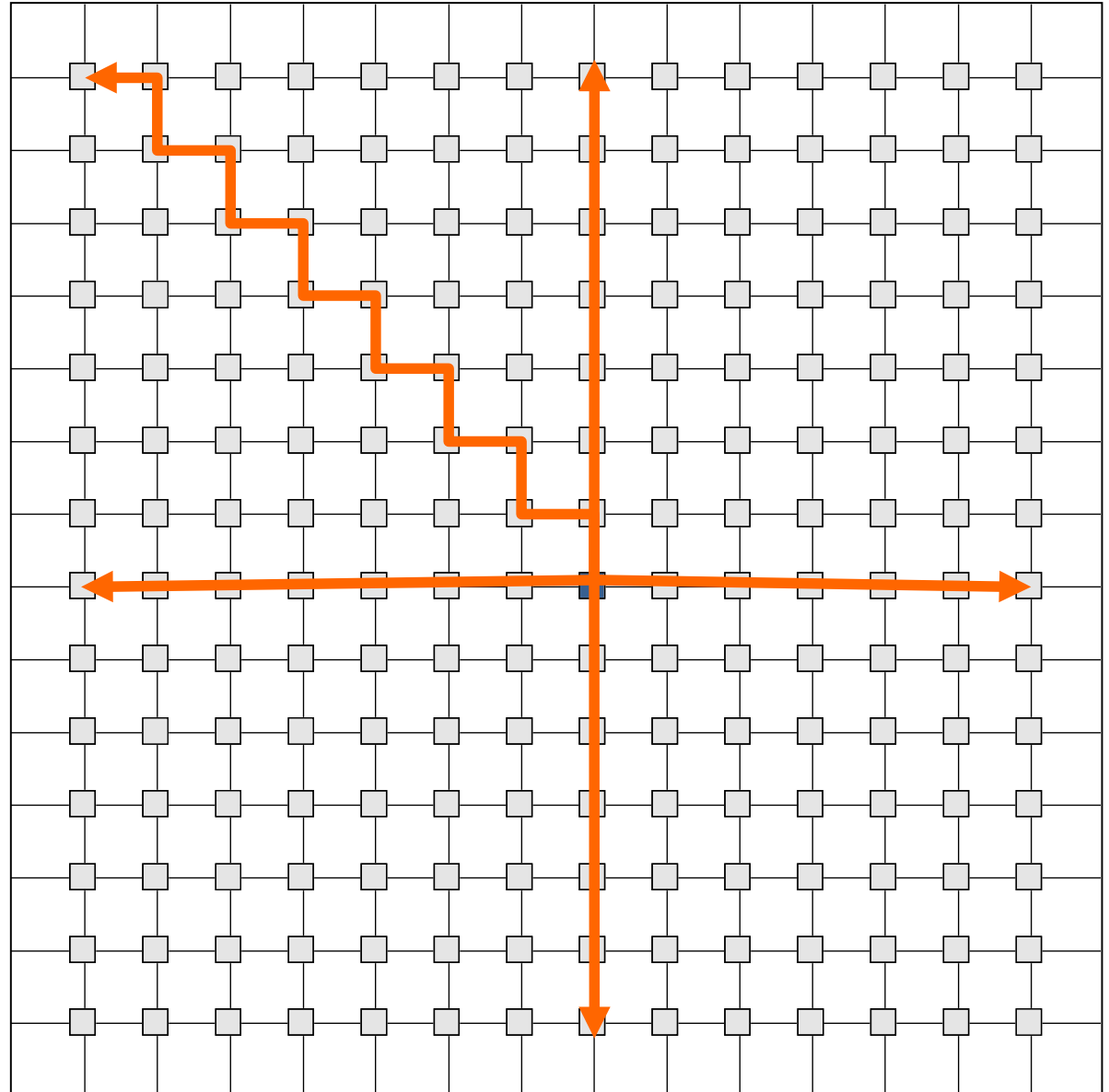

- Principles of operation:

## State 2

### Event monitoring and detection

Each node continuously senses the environment and communicates the sensed values with its n-hop neighborhood

Ex: n-hop = 3

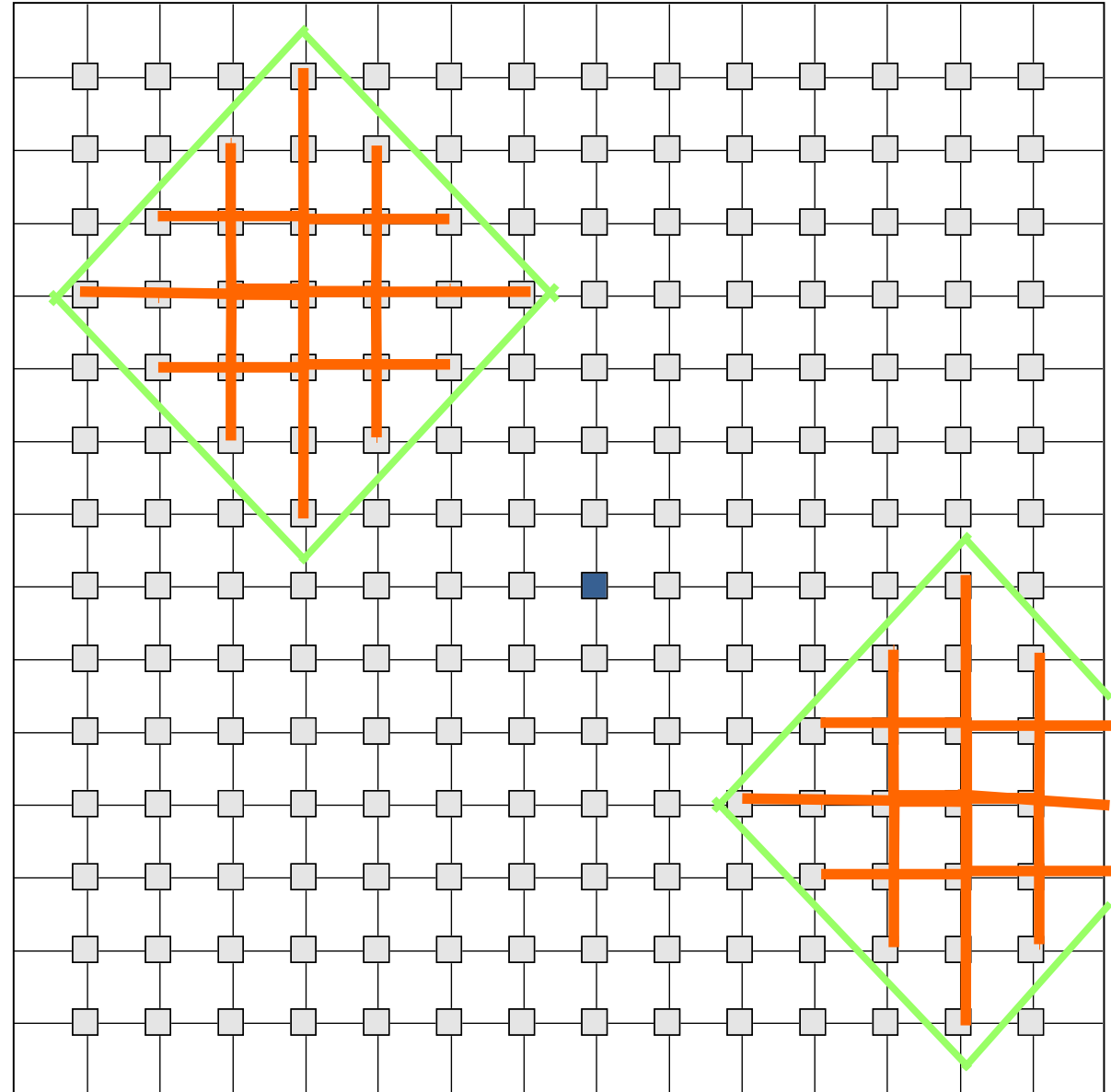

- Principles of operation:

## State 3

### Event announcement

On detecting a gradient in a given threshold windows:

Nodes transmit their data by forwarding a packet with the data

After transmission, nodes switch back to State 2

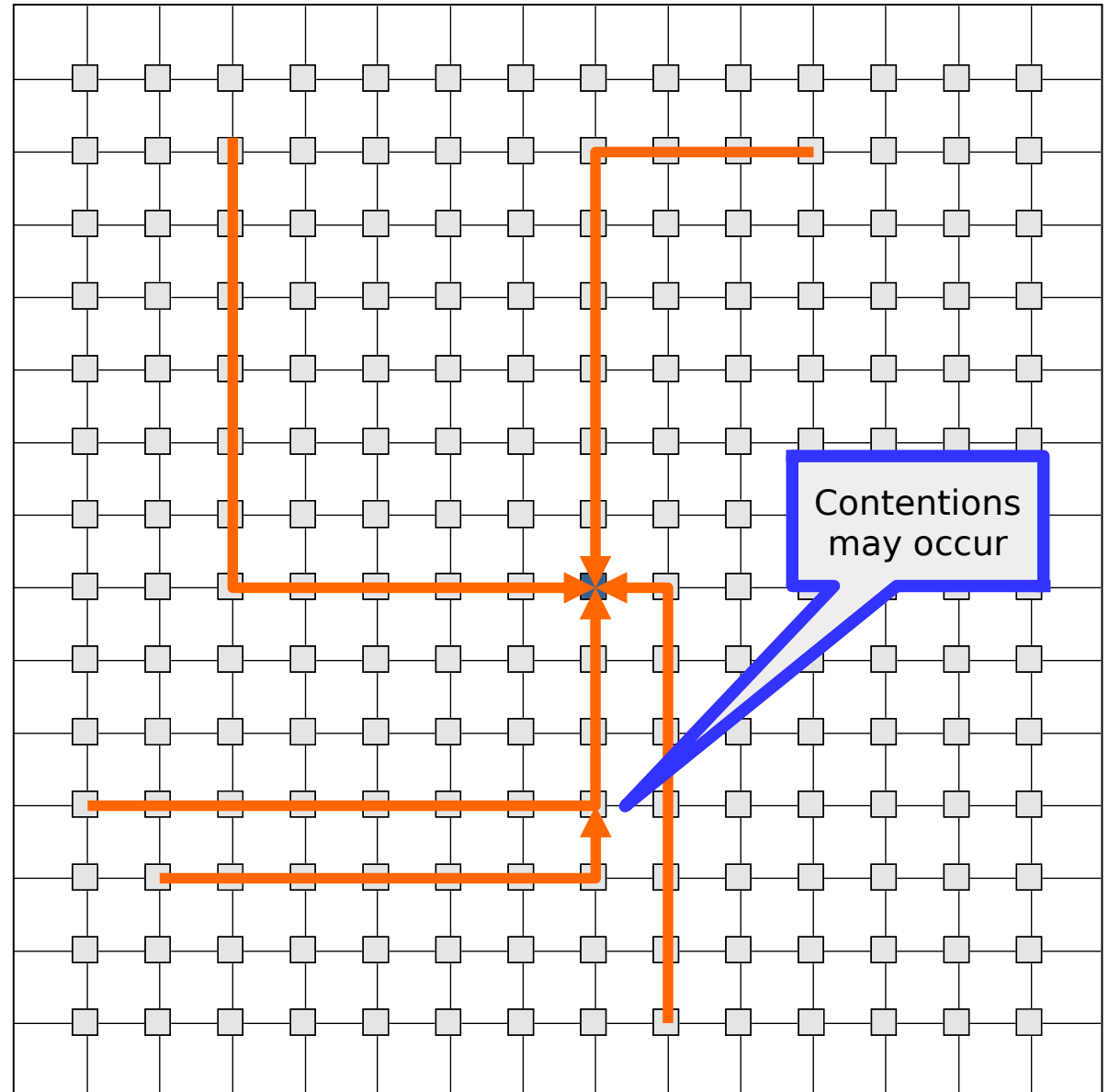



# Simulation Model

Based on the point-to-point network model from ns-3, a module was developed to simulate XDense

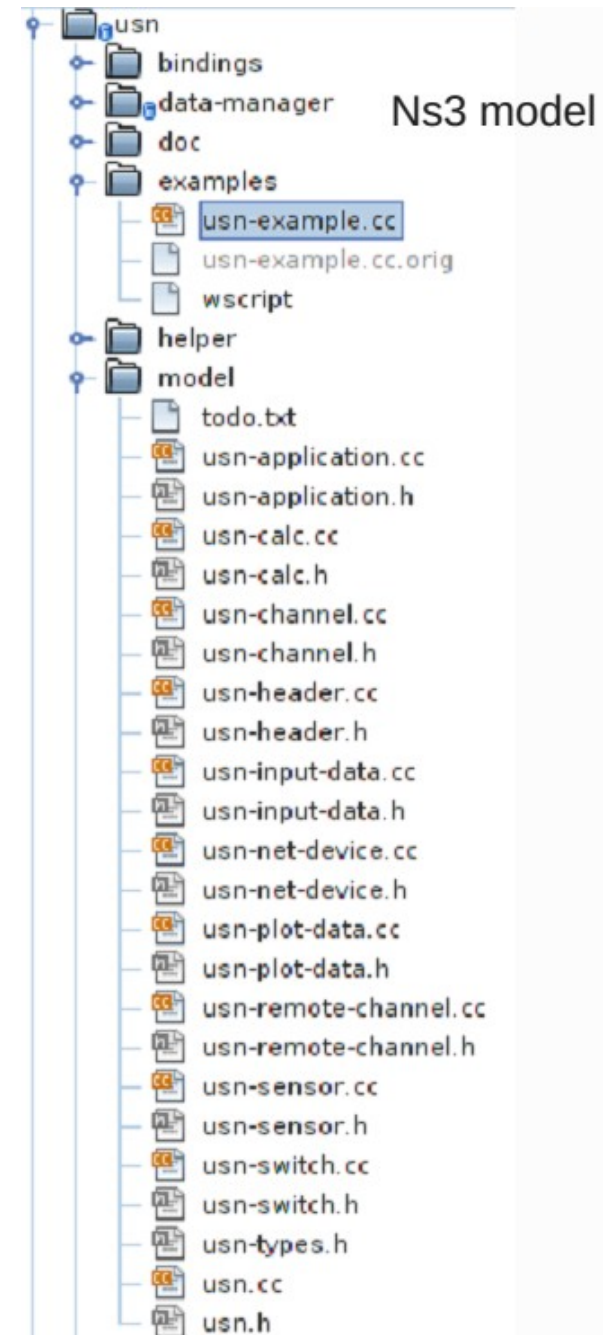
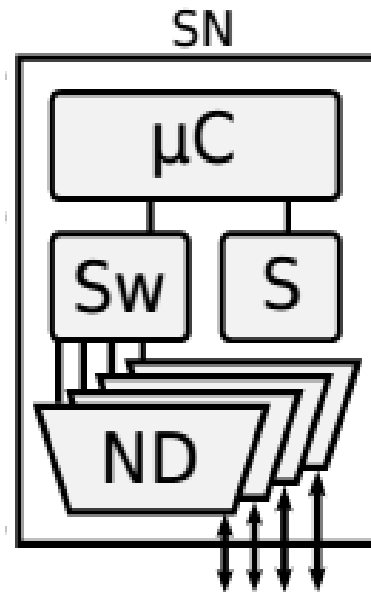



# Experimental Results

---

By connecting our model to the output data of computational fluid dynamics (CFD) simulations, we could evaluate some key aspects of XDense.

We perform two main experiments:

Data aggregation and compression for extracting data from the entire network;

Distributed feature extraction.

# Results

More recently, an algorithm for distributed data aggregation and compression was implemented in a network of **101x101 nodes** and a sink in the center.

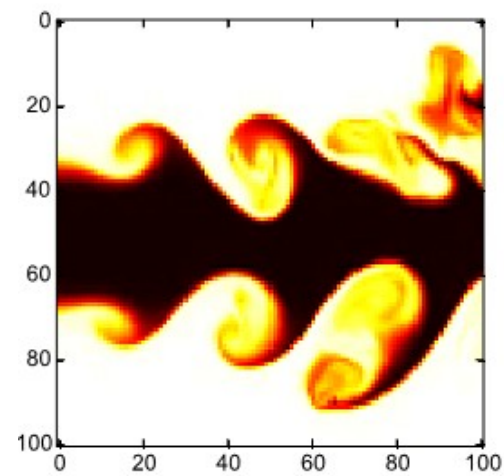
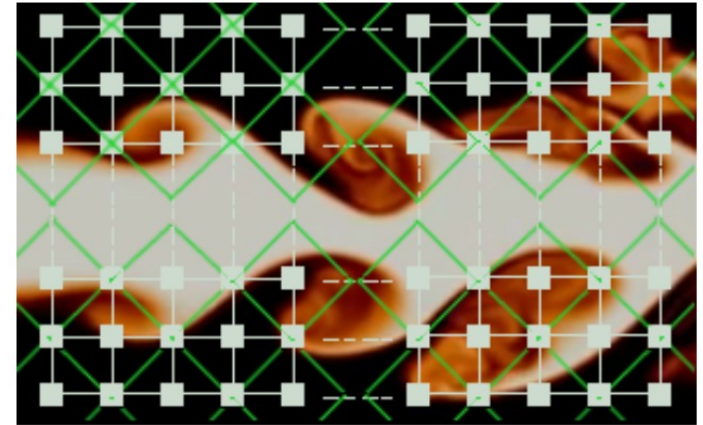

n-hops=1

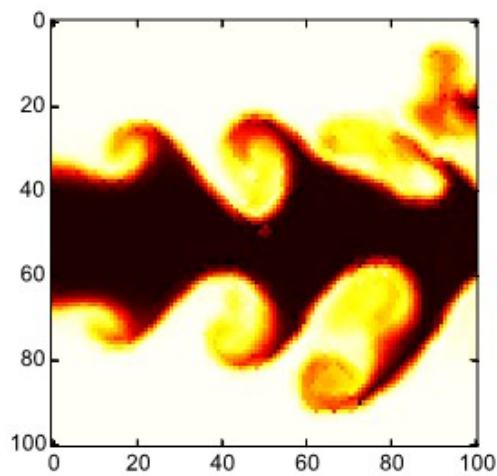

n-hops=2

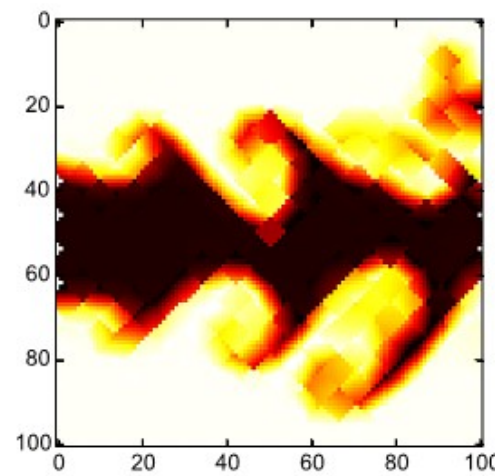

n-hops=4

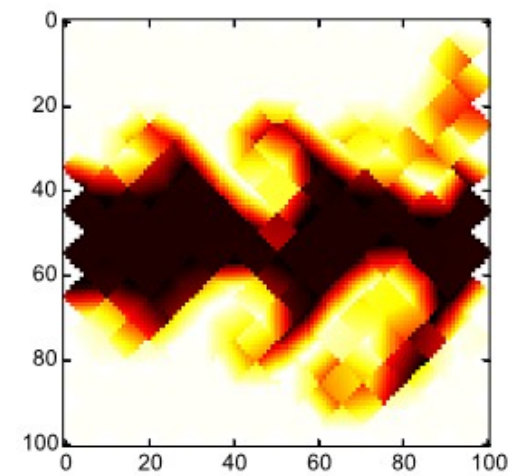

n-hops=5

# Results

We compare the number of receptions by the sink over time, for different values of  $n_{hops}$ .

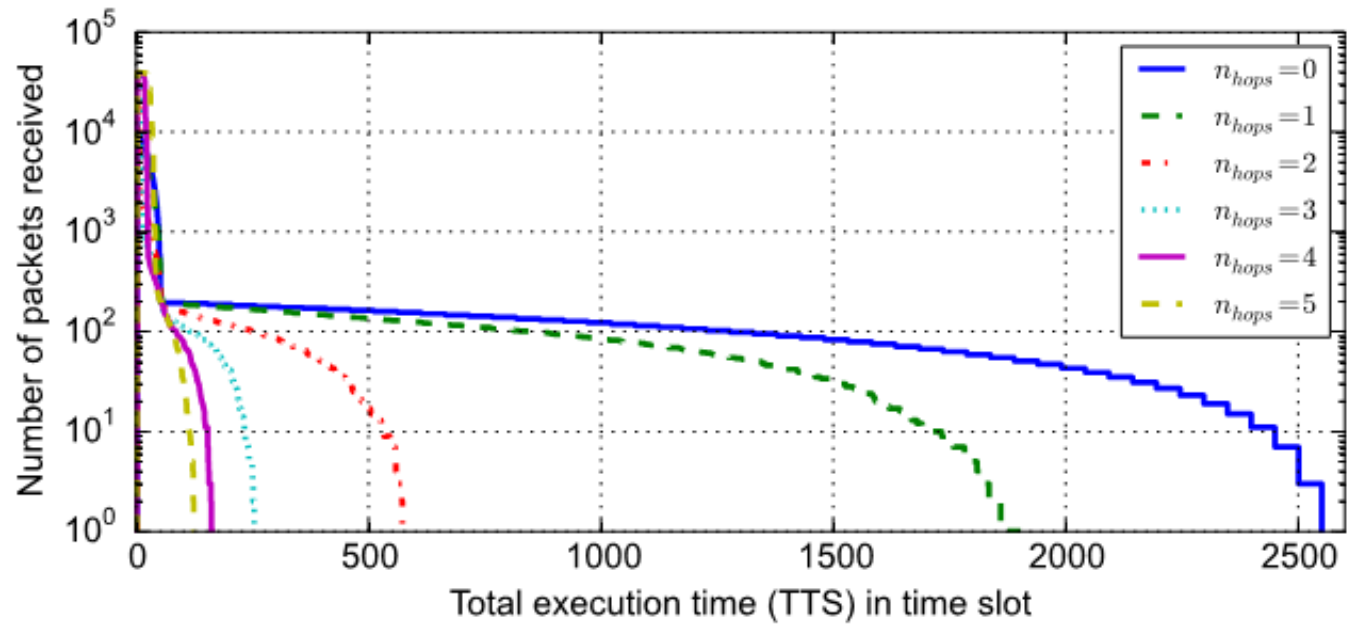

Zoom into the first 60 time slots.

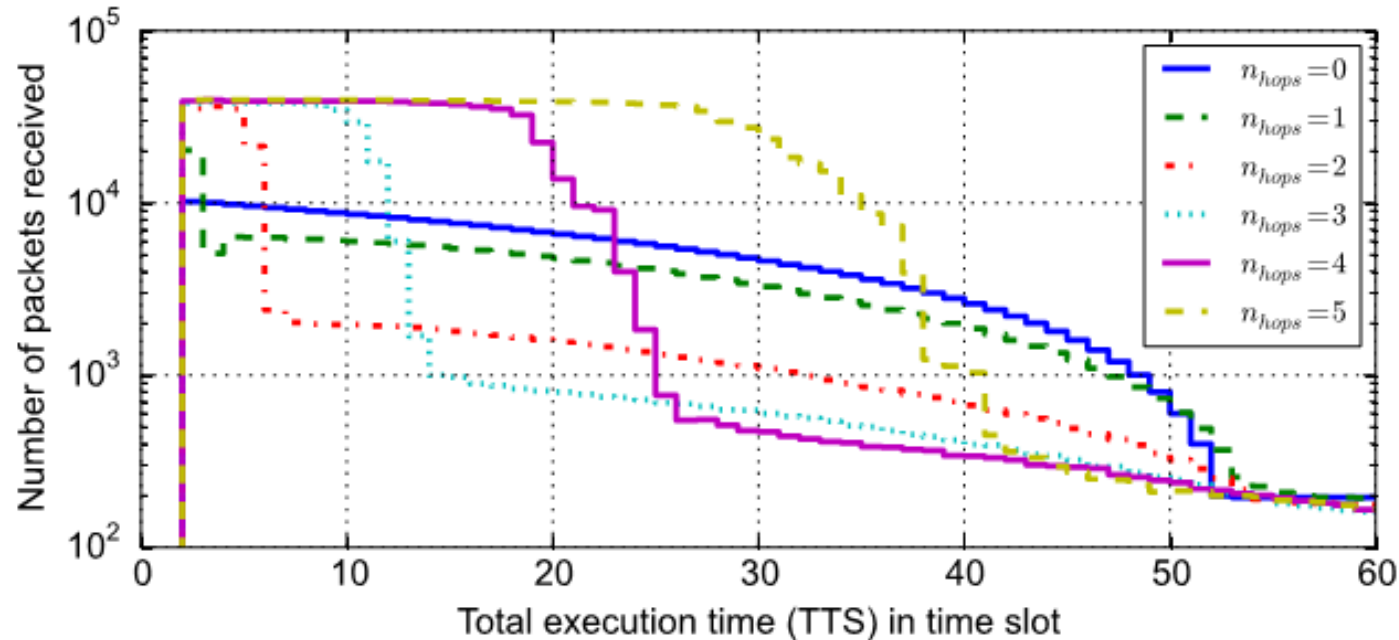

# Results

Trade-off between mean square error and maximum end-to-end delay for different values of n-hops

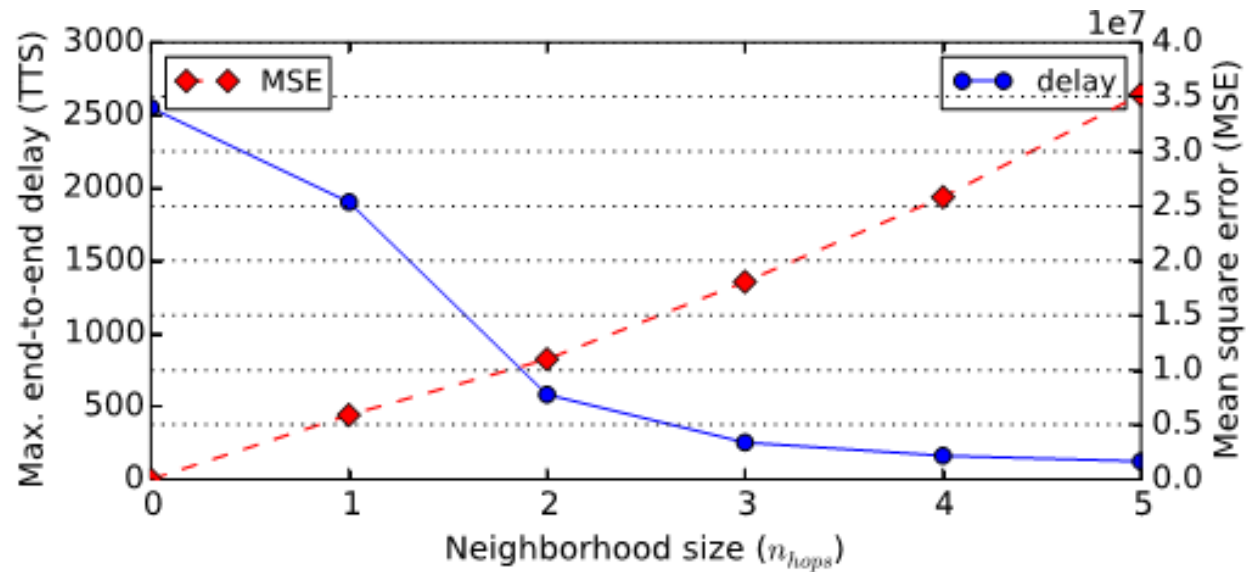

Maximum queue size for p0 and p1 for different values of n-hops.

p0 is used on DS and p1 on DA

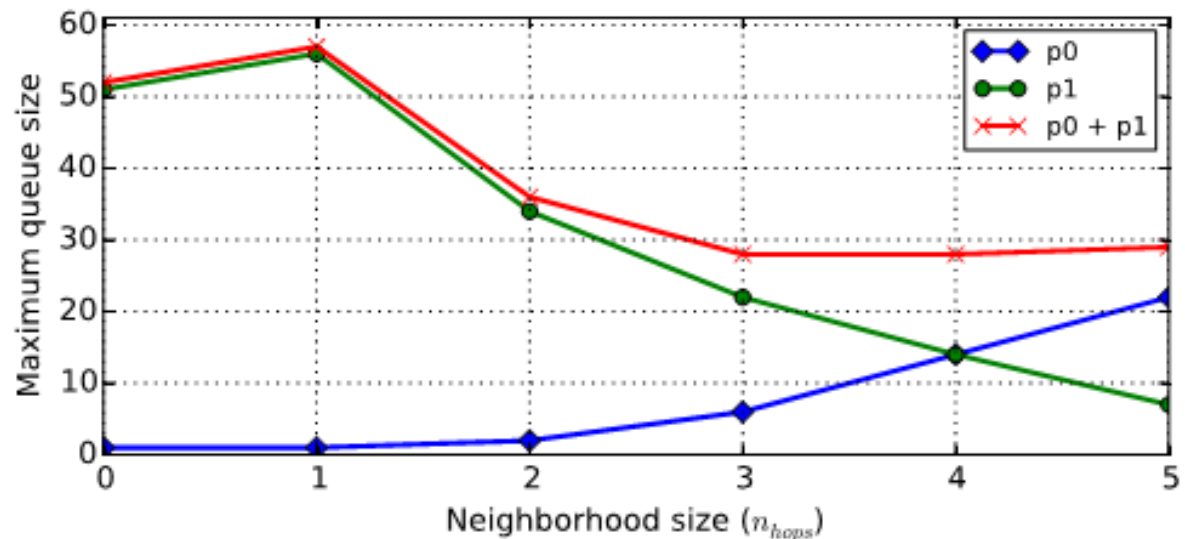

Using the same data-set, we apply edge detection algorithms for detecting the boundary layer (the region on the interface between laminar and turbulent regions):

We use the Sobel algorithm, widely used in image processing applications'.

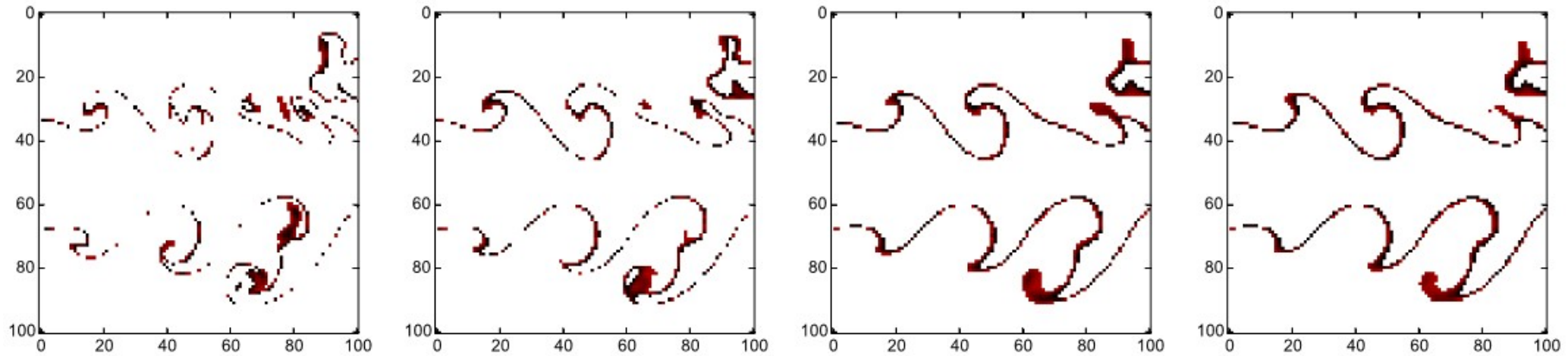

**Extracted boundary data for different values of  $n_{hops}$ : (a)  $n_{hops} = 1$  (b)  $n_{hops} = 2$  (c)  $n_{hops} = 4$  (d)  $n_{hops} = 5$ .**

# Results

Number of receptions by the sink over time, for different values of n-hops.

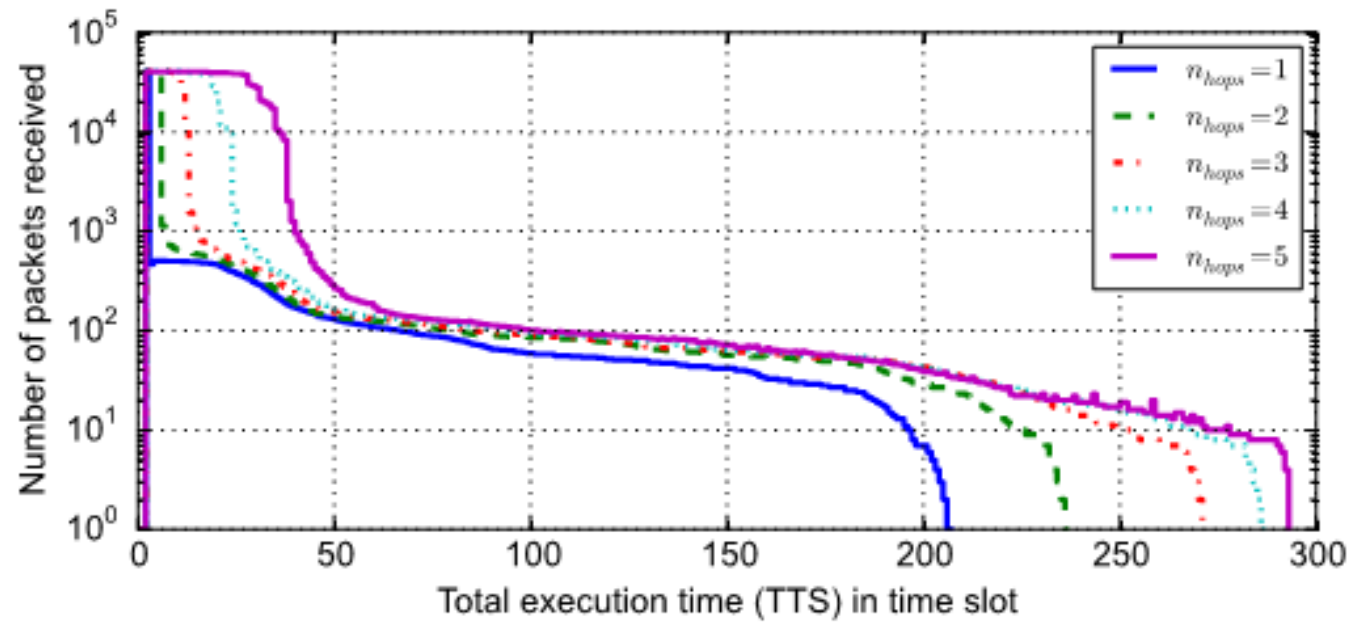

Queue size for the different protocols and values of n-hops.

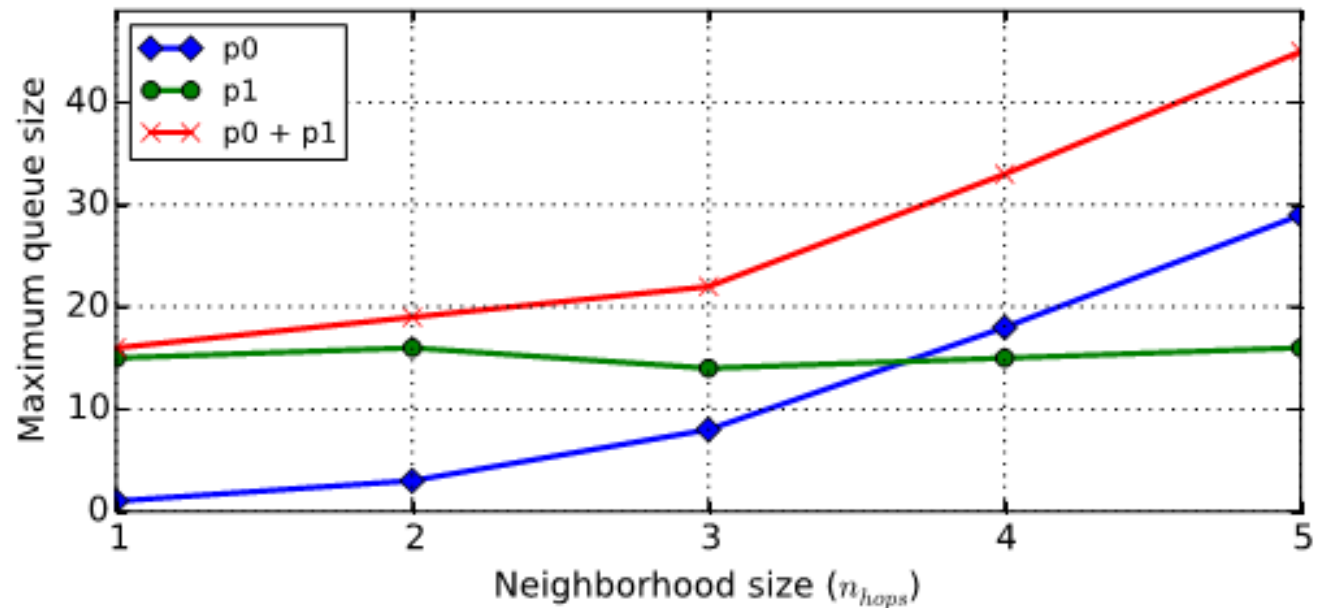

# Results

We also apply distributed edge detection algorithm in order to capture free air-jet flow's envelope, and evaluate the accuracy of our findings.

Free air-jet flow, captured using laboratory camera setup [1]

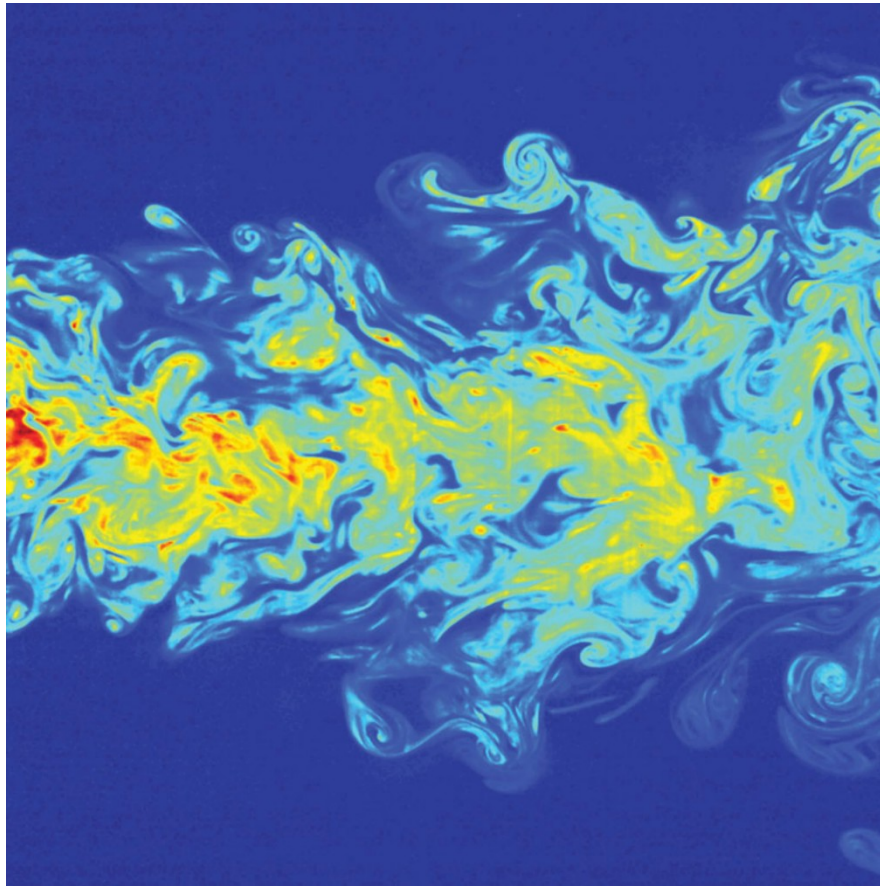



# Results

Referential results using image processing techniques proposed in [1]

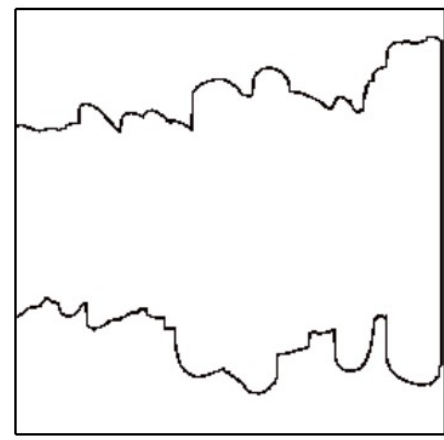
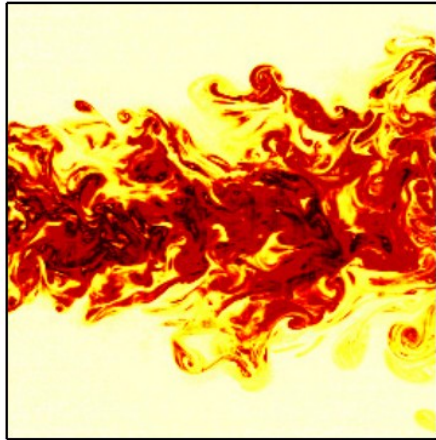

Our results, using in-network data processing in a network of **101x101** nodes, and **n-hops = 3**

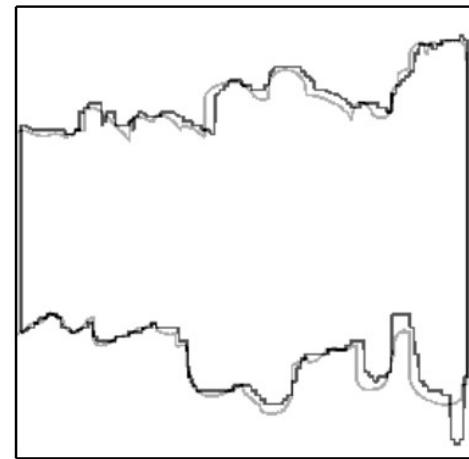
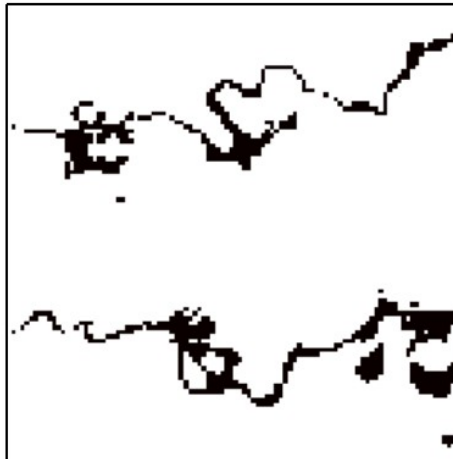
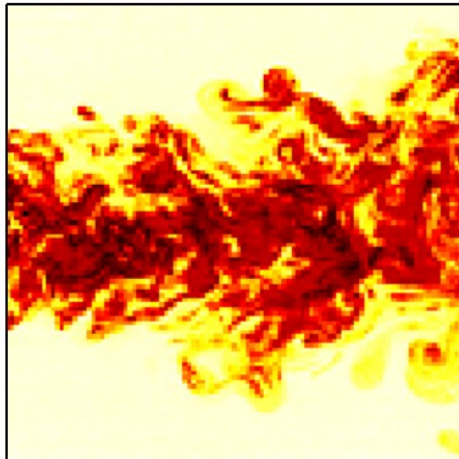



# Results

In another simulation scenario, the network model is fed with the output data of a CFD simulation, **over time**;

**51x51** temperature sensors deployed (equally spaced) over an 2D heated air flow, with a sink on center. This, in two different scenarios:

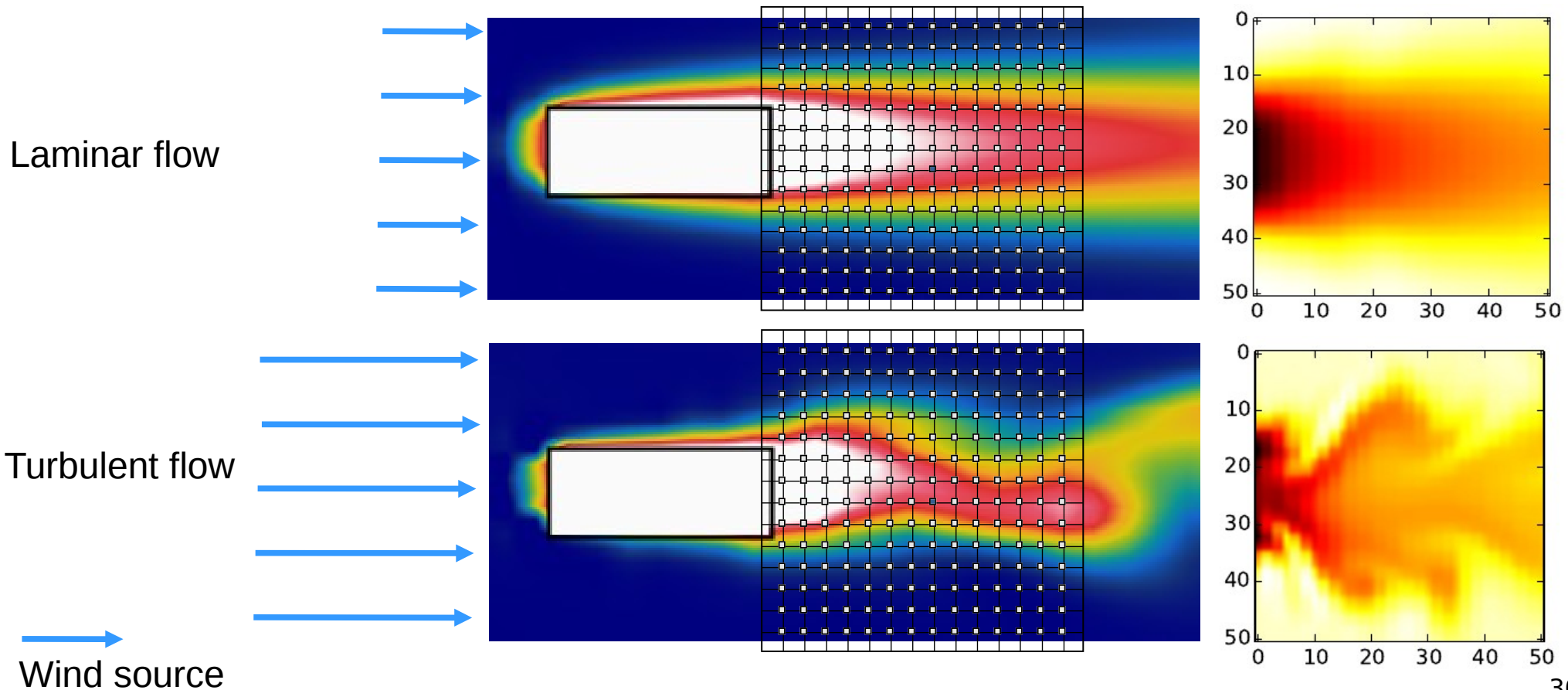

# Results

The simulation runs for 10 ms, with one sensor sample per ms by each node.

The number of transmission is minimized over time, depending on the dynamic of the observed phenomena.

## Laminar flow

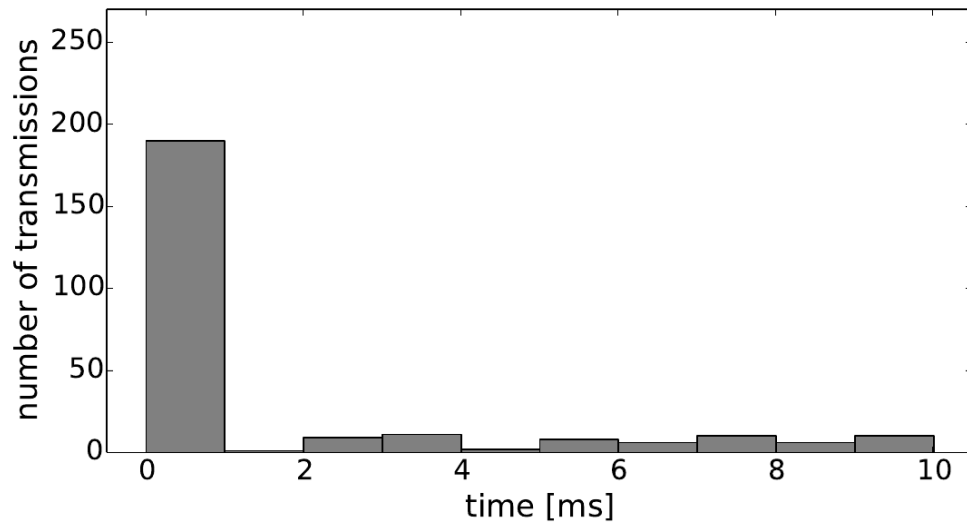

## Turbulent flow

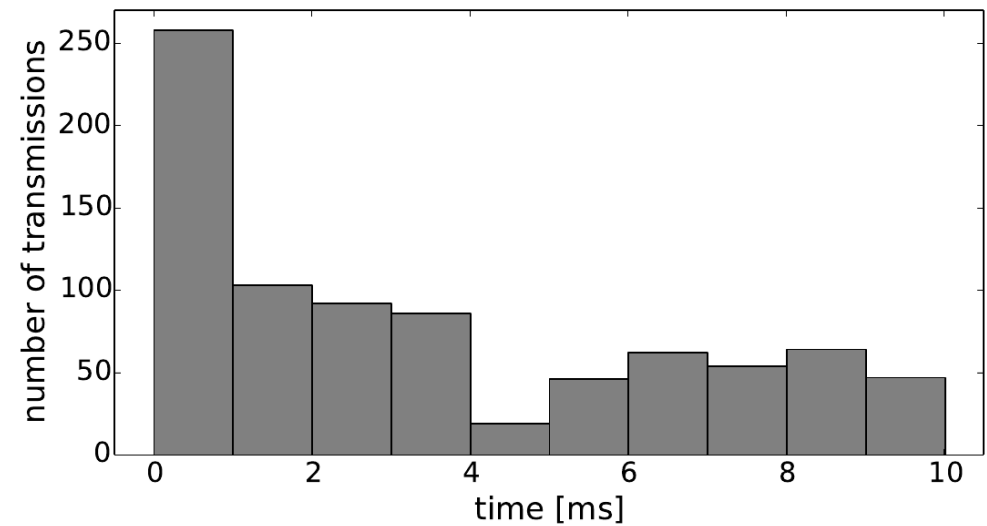

# Results

To validate our concept, a hardware prototype was projected using an Atmel ATSAM4N8AA microcontroller.

It is an ARM Cortex-M4 processor running at 100MHz

It has 5 serial ports and 23 DMA channels

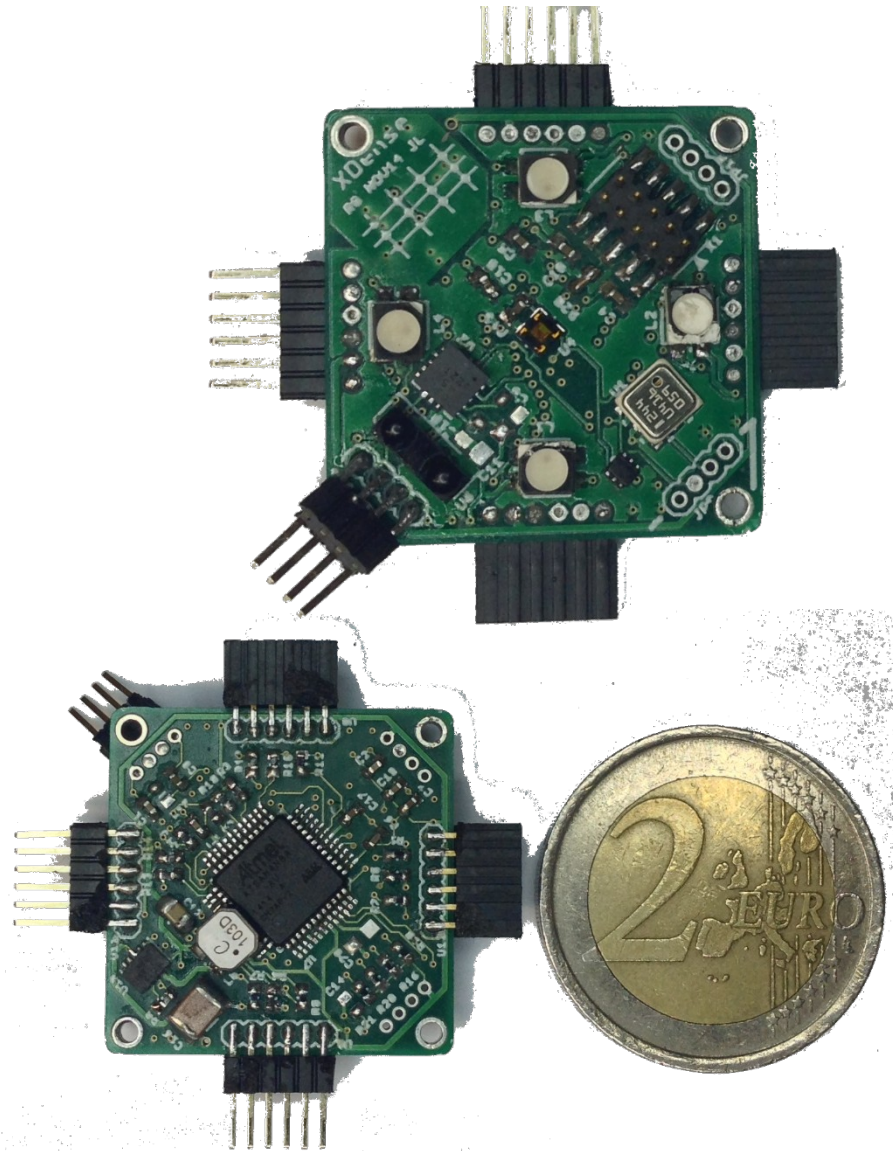
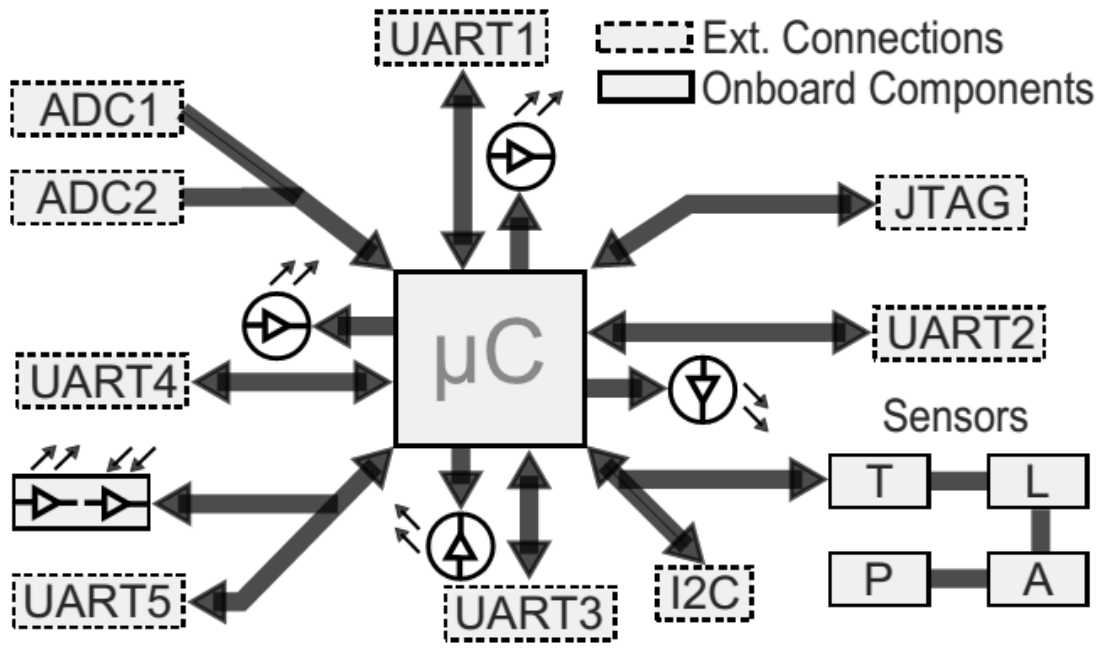

# What Next?

- We prototype Xdense with COTS microcontrollers, or either a dedicated SoC could be developed.
- Generic architecture addressing related appln scenarios
    - What features should be extracted?
    - Can architecture be independent of choice of sensor?
    - How to dimension network based on phenomena?
    - How to simulate data input precisely
  - Comparative analysis and metrics
    - Which approaches should be the base of comparison?
    - What metrics?
    - How to do timing analysis for real time applications?
  - Different scenarios should be explored, for example: structural monitoring, vibration analysis,